

Self-deployable Habitat for Extreme Environments – Universal Platform for Analog Research

Ondrej Doule, Ph.D.¹

Space Innovations, Řečany nad Labem, Czech Republic

Barbara Imhof, Ph.D.², Waltraut Hoheneder³, Stephen Ransom⁴, René Waclavicek⁵
LIQUIFER Systems Group, Vienna, Austria

Priit Kull⁶, Alvo Aabloo, Ph.D.⁷

IMS Lab, Institute of Technology, University of Tartu, Estonia

Peter Weiss, Ph.D.⁸, Virginie Taillebot, Ph.D.⁹, Bernard Gardette, Ph.D.¹⁰, Thibaud Gobert¹¹
COMEX SA, Marseille, France

Jeremi Gancet, Ph.D.¹² Pierre Letier, Ph.D.¹³, Gonzalo Rodriguez¹⁴, Joseph Salini¹⁵
Space Application Services, Bruxelles, Belgium

Joshua Nelson¹⁶, Chris Welch, Ph.D.¹⁷

International Space University, Strasbourg, France

and

Petr Gajdoš¹⁸, David Ševčík, Ph.D.¹⁹

Sobriety s.r.o., Brno, Czech Republic

¹ Space architect, managing director, Space Innovations, Obránců míru 107, 533 13 Řečany nad Labem, Czech Republic, AIAA regular member, AIAA SATC chair

² Space architect, managing director, 'LIQUIFER Systems Group, Obere Donaustraße 97-99/1/62, 1020 Vienna, Austria, AIAA Senior Member

³ Architect, managing director, 'LIQUIFER Systems Group, Obere Donaustraße 97-99/1/62, 1020 Vienna, Austria

⁴ Systems engineer, associate, 'LIQUIFER Systems Group, Obere Donaustraße 97-99/1/62, 1020 Vienna, Austria

⁵ Space architect, associate, 'LIQUIFER Systems Group, Obere Donaustraße 97-99/1/62, 1020 Vienna, Austria

⁶ Engineer-developer, IMS Lab, Institute of Technology, University of Tartu, Nooruse 1, 50411, Tartu, Estonia

⁷ Professor, IMS Lab, Institute of Technology, University of Tartu, Nooruse 1, 50411, Tartu, Estonia

⁸ Manager, Innovation and Space Division, COMEX SA- Marseille, p.weiis@comex.fr

⁹ Project engineer, Innovation and Space Division, COMEX SA- Marseille, v.taillebot@comex.fr

¹⁰ Scientific Director, COMEX SA- Marseille, b.gardette@comex.fr

¹¹ Project Engineer, Innovations and space division

¹² Robotic Systems Team Leader, Space Applications Services NV., Leuvensesteenweg 325, 1932 Zaventem, Belgium

¹³ Robotics Engineer, Space Applications Services NV., Leuvensesteenweg 325, 1932 Zaventem, Belgium

¹⁴ Mechanical Engineer, Space Applications Services NV., Leuvensesteenweg 325, 1932 Zaventem, Belgium

¹⁵ Robotics Engineer, Space Applications Services NV., Leuvensesteenweg 325, 1932 Zaventem, Belgium

¹⁶ Project Engineer, International Space University, 1 Rue Jean Dominique Cassini, 67400 Illkirich-Graffenstaden, France

¹⁷ Masters Program Director, International Space University, 1 Rue Jean Dominique Cassini, 67400 Illkirich-Graffenstaden, France, AIAA Associate Fellow

¹⁸ Design engineer, R&D Division, Sobriety s.r.o., Brno, Czech Republic

¹⁹ Project manager, R&D Division, Sobriety s.r.o., Brno, Czech Republic

The Self-deployable Habitat for Extreme Environments (SHEE) presents a unique platform for multidisciplinary analog research and mission simulation for future planetary exploration. This project is currently under development through a grant from the Seventh Framework Programme of the European Union (EU-FP 7) by a large interdisciplinary team of experts. The habitat prototype will serve as a space mission simulator complementary to existing habitats in use by NASA, the Mars Society, and other organizations. SHEE will represent a unique European platform collaboratively developed by seven European companies and Universities. The project Consortium aims to find reciprocities between extra-terrestrial and terrestrial applications especially in extreme environments or disaster settings. This paper describes the research capacities of SHEE as an analog simulator. Since the habitat is deployable and thus transportable it can be shared by a large international community for analog testing and simulation. The habitat strives to provide research in many areas of human space exploration.

Nomenclature

<i>Habitat</i>	=	Building enabling human presence in extreme environments
<i>HDU</i>	=	Habitat Demonstration Unit
<i>PEM</i>	=	Pressurized Excursion Module
<i>SHEE</i>	=	Self-deployable Habitat for Extreme Environments

I. Introduction

There are many extreme environments both on and off the Earth that are hostile to human life. Despite these conditions, humans enter these environments in order to search for resources, explore, conduct research or leisure or to respond to emergencies. The Self-deployable Habitat for Extreme Environments (SHEE) consortium was formed to develop a new habitat design accounting for numerous environmental and utilization design drivers¹. Unlike existing habitats such as the NASA Human Exploration Research Analog (HERA)² facility (former Habitat Demonstration Unit)³, the Mars Society Mars Desert Research Station (MDRS)⁴, the Flashline Mars Arctic Research Station (FMARS)⁵, the NASA Haughton Mars Project⁶, the Hawaii Space Exploration Analog and Simulation (HI-SEAS)⁷, Aquarius⁸ and others, the SHEE design utilizes rigid deployable segments to create a large, portable habitat environment suitable for use in both terrestrial and extra-terrestrial hostile environments.

This paper introduces all aspects of the SHEE including the design process, design characteristics, habitat operations and deployment and its applicability in space and terrestrial research.

There are many architectural solutions for integration of space and terrestrial design requirements. The SHEE design was required to be redundant, cost efficient and have a high ratio of deployed to packed volume. Cost effectiveness of the habitat fabrication was an essential design driver as the funding for maturation of the complex technologies required would be much higher than the resources available. A further important design driver is the level of simulation fidelity or, in other words, functional similarity between the simulator/analog system and the approximated real system to be used in extreme environments.

For example: NASA Apollo analog systems designers had one huge advantage compared to the SHEE design team. The Apollo analogs were designed for a specific space mission; hence the analog systems were as high fidelity as could be attained by terrestrial technology at that time. Since the SHEE is demonstrating technology that could be used in a variety of environments, significantly more constraints and considerations are being taken into account than with any previous analog habitat project. SHEE represents quite the opposite approach to the Apollo analogs as it represents a universal surface platform which can be flexibly implemented for a variety of research and missions according to the researchers' needs.

II. Design and testing through Analogs

When designing for extreme environments it is frequently necessary to test designs in a friendlier environment that mimics some characteristics of the extreme environment. These analog environments provide engineers with the opportunity to increase the technology readiness level of their design without the added expense, complexity and constraints of deploying it in the real environmental conditions.

Analogs have been used since the dawn of the space industry. During the American Apollo program, every piece of equipment was tested in the most Moon-like environments to be found on Earth to increase the chances it would

work on the lunar surface. Analogs were also used to train the astronauts in what to expect when they landed on the Moon (Figure 1).⁹

The first habitat currently under construction by the SHEE consortium will only be a test bed to study the feasibility of the SHEE design. Once testing of this initial design is complete, it will be available for simulations in nominal, extreme or laboratory environments.

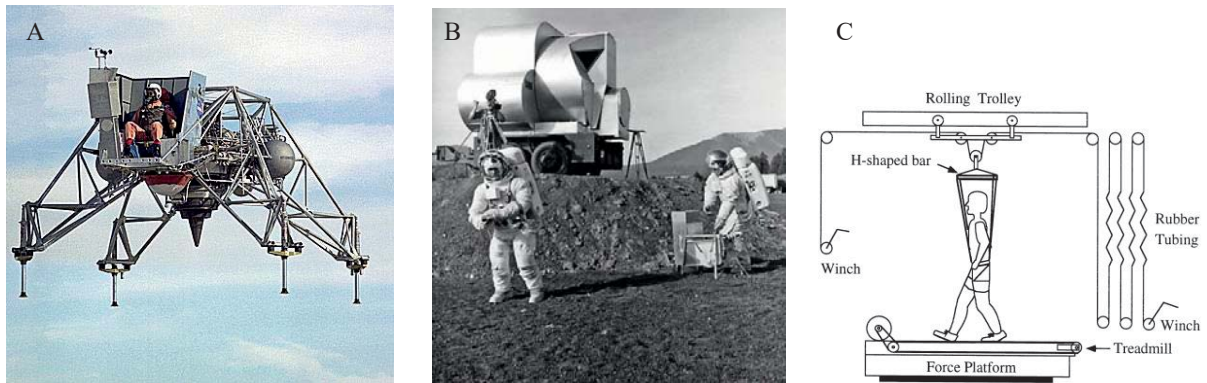

Figure 1: (A) NASA Apollo Lunar Landing Research Vehicle, (B) Apollo surface habitat analog¹⁰ and (C) lunar gravity simulator¹¹ represent analogs used during the Apollo missions⁹.

III. Self-Deployable Habitat for Extreme Environments

The habitat for a crew of two people comprises of five functional areas and a small toilet. There are two port-mounts located opposite each other at the “Entrance port” that can be used either as suit ports or docking ports for pressurized rovers (see Figure 2 below). Deployable work and private areas are located opposite each other, separated by the entrance areas and kitchen. The confined environment is complemented by deployable furniture and integrated wall storage and equipment. For more detailed layout drawings see Appendix 1.

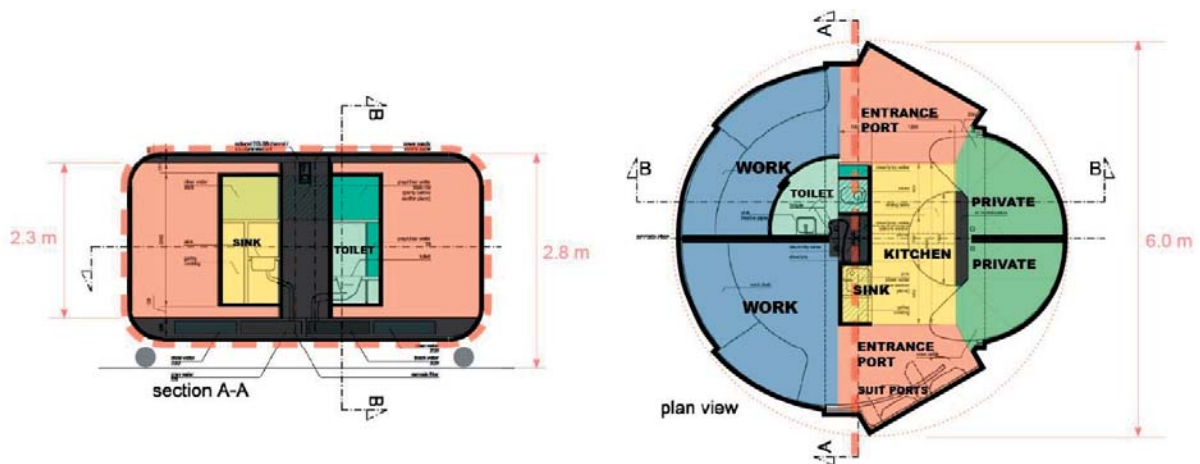

Figure 2: SHEE functional scheme - section and plan view.

A. Logistics, layout and operating environments

The SHEE habitat is designed to fit within the shroud of existing heavy lift launcher vehicles (such as Ariane V) and standard road transportation dimensions using truck and trailer. Thus it can simulate a small habitat for

planetary use in real scale in addition to providing affordable transportation from one simulation site to another around the world (see Figure 5).

In comparison, the NASA HDU is also transportable but only as an oversized cargo extending one meter over the truck load area on both sides¹² (Figure 4) and requiring non-automated assembly on the research site. In total there were three trucks required for the transport of all research HDU equipment to a research site: two trucks with trailers and one command bus.

Similarly to the NASA HDU, the SHEE test bed will require a crane platform for unloading the folded simulator from the truck⁷ (Figure 3). However, unlike the NASA HDU, the SHEE can be equipped with its own wheels that allow it to be moved on flat surfaces once unloaded from the truck. The SHEE design complies with mega-trailer road transport requirements in Europe and does not require special (Figure 5) transport. Mega-trailers can transport a maximum cargo height of 3.00m. Their transport costs are not substantially higher than for standard trucks. They are not special transports as they do not exceed the sizes of standard road transport, but provide a lower loading bed. Taking into account a minimum of manipulation space, the size for SHEE was defined with a maximum width of 2.40m and a maximum height of 2.80m to be easily transported by a mega-trailer.

The SHEE will be equipped with a deployable, pre-integrated and transformable interior and a basic Life Support System as well as standard interfaces to simulate EVA procedures of ingress and egress if equipped with suit ports. The habitat ports are equipped with a modular wall interface that could be used as a suit port or as a connection to an adjacent habitat or a rover. The SHEE habitat supports the needs of two crewmembers as an independent base with minimum infrastructure for a limited simulation time (two days to two weeks). It provides certain autonomy of the hygiene systems and power systems with replaceable and maintainable consumables to ensure life-long research and operations.

B. Habitat operations, safe modes and deployment

SHEE will be operated by at least one instructed person following all safety procedures prior to its initiation. All necessary hardware including ECLSS, kitchen equipment, the hygiene facility and other furnishings is integrated. Hardware will be placed in the habitat before deployment or prior folding. The highly flexible interior furnishing provides numerous possibilities to rearrange the interior according to alternative mission requirements or personal needs.

A large translational zone of approx. 2 m width and 5 m length spans between the two interface elements which either connect to other modules (docking hatch) or to the outside (EVA suit ports or airlock). Due to its dimension this area can be used for a variety of additional functions still fulfilling its primary translational function. The slightly different sizes of the deployable quadrant areas allow for a variation of layout configurations according to habitability priorities.

In addition, the transformable interior furnishing increases the functional variety substantially. The deployable interior elements not only ensure multi-functionality but also allow the astronaut to personalize his/her environment according to individual needs or personality. Depending on the priorities with regard to different mission scenarios the design allows easy adaptation for an alternative



Figure 3: Unloading of the NASA HDU-PEM from the trailer.



Figure 4: NASA HDU-PEM could be transported only as a super wide-load payload.

1x SHEE for terrestrial applications



6x SHEE for space applications

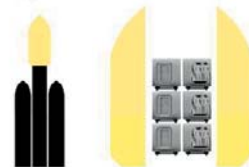

Figure 5: SHEE design drivers are merging logistical requirements from space and terrestrial applications.

focus on close collaboration and living together or promoting privacy.

The deployment of the base will be performed in different modes according to the selected level of autonomy and it will be fully robotic without the need for human intervention. The deployment sequence has fail-safe modes – consisting essentially in (1) redundant actuation mechanisms, and (2) manual actuation backup.

The deployment is performed in the following sequence (see Figure 6):

- Activation of the on-board computer
- Interleaved opening of the large petals and small petals, asynchronously (to minimize stability concerns)
- Locking of the habitat geometry
- Sealing of the habitat interior
- Hatch unlocking

The SHEE structure could then be crewed in the following sequence:

- Docking from the crew capsule
- Crew and consumables (clear water) boarding/unloading
- Manual procedures by the crew (electrical connection, pipe connection)
- The folding is performed after the crew departure in the following sequence:



Figure 6: SHEE Deployment sequence scheme.

SHEE has been designed as a unit corresponding to a one building module of a habitat, camp or settlement cluster. The Figure 7 shows the capacity of SHEE to connect in efficient geometrical patterns. Each base can be interconnected to other SHEE units in different ways. In addition to linear and circular patterns, many other geometrical patterns can also be envisaged. A SHEE greenhouse module can be connected to a laboratory and a habitat, being placed either between the two other modules or on the end, as appropriate. This would depend on the mission and operation scenario.

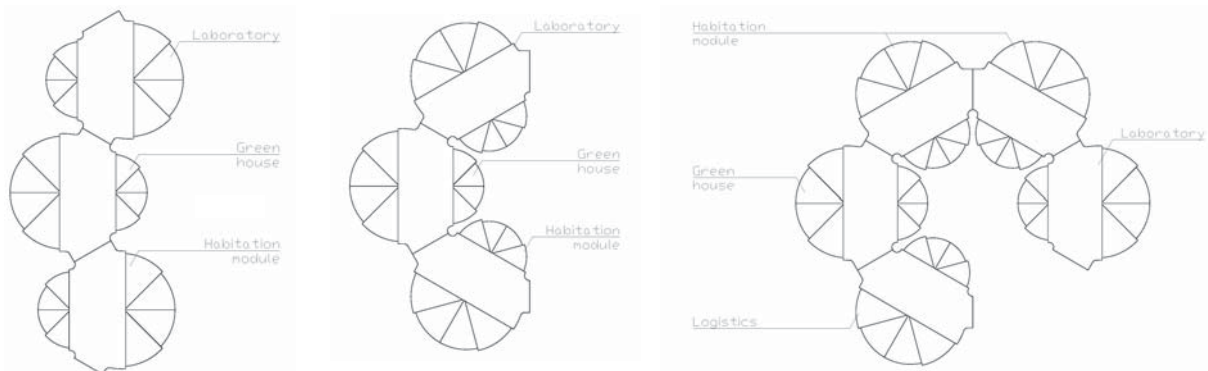

Figure 7: SHEE habitat modules combined in linear and circular arrangements.

C. Habitat operational environment

1. Environmental constraints in space

To design a habitat for habitation and survival in extreme conditions requires broad spectrum knowledge of physics, engineering and sciences. The SHEE is designed for extreme terrestrial, lunar and Martian conditions, so the relevant climatic conditions, temperatures and wind behavior, radiation loading etc. of these extraterrestrial bodies have to be understood, considered and classified according to their relevance.

The initial SHEE concept design was used for validation of the preliminary virtual environments based on an overview of physical and technical information (such as geometrical form, materials, dimensions of the habitat etc.) and environmental data acquired mostly from NASA scientific resources. Following this, the ability of the designed habitat to survive in extreme conditions as described in the following paragraphs, and its ability to survive travel to and landing on the base of an extraterrestrial body, was tested.

- The extreme conditions considered were:

1. For a lunar base:

The Moon's surface temperatures¹³ are among the most extreme of any planetary body in the solar system. The equatorial and mid-latitude daytime temperatures are close to 107 degrees Celsius, and then decrease pole-ward of 70 degrees north latitude. Equatorial and mid-latitude nighttime temperatures are close to -178 degrees Celsius and then decrease pole-ward of 80 degrees north latitude.

The lack of atmosphere on the lunar surface, no wind¹⁴, radiation and a very long day-night period (1 lunar day is 27.3 Earth days) represent very specific extreme environment.

2. For a Mars base:

The temperature on Mars¹⁵ may reach a high of about 20 degrees Celsius at noon at the equator in the summer, or a low of about -150 degrees Celsius at the poles. In the mid-latitudes, the average temperature would be about -50 degrees Celsius with a nighttime minimum of -60 degrees Celsius and a summer midday maximum of about 0 degrees Celsius.

Mars is a very windy environment. The Mars atmosphere always has a thin veil of suspended dust particles, the amount of which varies with location and season. Based on the result of NASA's Viking Mission to Mars¹⁶, wind speeds are 2 - 7 m/s in summer, 5 -10 m/s in fall, and 17 - 30 m/s in dust storms. The dust in the atmosphere has the important role of absorbing incoming solar radiation. In the case of a huge planet, encircling dust storms and the resulting absorption of incoming solar radiation can lead to global warming of the planet¹⁶.

The terrestrial climate can also be very harsh. The common thermal load is generally between 45 degrees Celsius plus or minus 25 degrees Celsius, but throughout the centuries the most extreme values recorded have been 56.7 degrees Celsius plus for Furnace Creek Ranch, Death Valley, California and minus 89.2 degrees Celsius for Vostok Station, Antarctica¹⁷.

In addition, wind loading can start from a mild 5 m/s breeze, but major storms, hurricanes and dust storms can also be found on Earth.

2. *External environmental conditions for the terrestrial analog:*

SHEE systems are designed for nominal terrestrial environments. The deployment can be performed in environments with the following parameters:

- LSS specifications using Temperature range [0°C – 40°C]
- Humidity range [25% – 70%]
- The habitat can withstand wind speeds of up to 145 km/h (once deployed)

3. *Internal environmental conditions:*

The habitat provides volumetric capacity and semi-private crew quarters for two people. The habitat fits in a 6m diameter operational circle plus a safety margin of 0.5 m around the habitat. The consumables defined in the mission specifications are limited in accordance with the given maximum volumes for water and sewage storage tanks. Foldable furniture and semi-furnished working areas allow for flexibility of the interior. The interior can be transformed according to the required research, based on consultancy with the SHEE operator established by the SHEE consortium.

The internal structure provides fixed core systems between the port entrances and deployed areas for work and private activities. The separation of the spaces is not definite. All areas in the interior are open without doors except for the hygiene cabin with a hygiene sink and a toilet (Figure 2).

The ECLSS subsystem ensures the biological autonomy of the crew while isolated on a planetary surface (or during an analog simulation mission). The objective is to have a partially regenerative system that can serve to train crewmembers in the use of such equipment and to serve as a potential test platform for future design and test of closed-loop ECLSS for long duration space missions.

The power systems provide necessary autonomy for deployment and system initiation. However SHEE is not energy self-sufficient and requires an external power source for recharging its 600Ah batteries.

- Capacity: 2 people for 1 day closed loop / 2 weeks open loop
- ECLSS main features:
 - o Drinkable water: 600 L
 - o Grey water storage: 220 L
 - o Filtered water storage: 25 L
 - o Black water storage: 200 l
 - o CO2 scrubbers for a closed loop system autonomy of 24:00h
 - o Automated monitoring of atmospheric parameters (O2, CO2, temperature, hygrometry rate)
- Interior flexibility - Structural load by internal equipment limits
 - o LSS racks: the hygiene facilities rack, kitchen facilities rack and monitoring & air management rack are foreseen to be removable to allow interchange with another if needed (e.g. a lab rack).
- Power (grid): 10 kW
- 600 Ah rechargeable battery (fuel cell - optional)
- Output 24 V (DC), 200 V (AC)
- Mass: Approx. 6 000 kg

In comparison with the NASA Apollo mission where the surface habitat had a habitable volume¹⁸ of 6.65m³ and supported 3 day missions with its consumables (see Figure 8), SHEE provides approximately 50 m³ after subsystems deployment and allows comfort and numerous research activities over a period of two days in closed loop mode and longer operations, up to two weeks, in open loop mode.

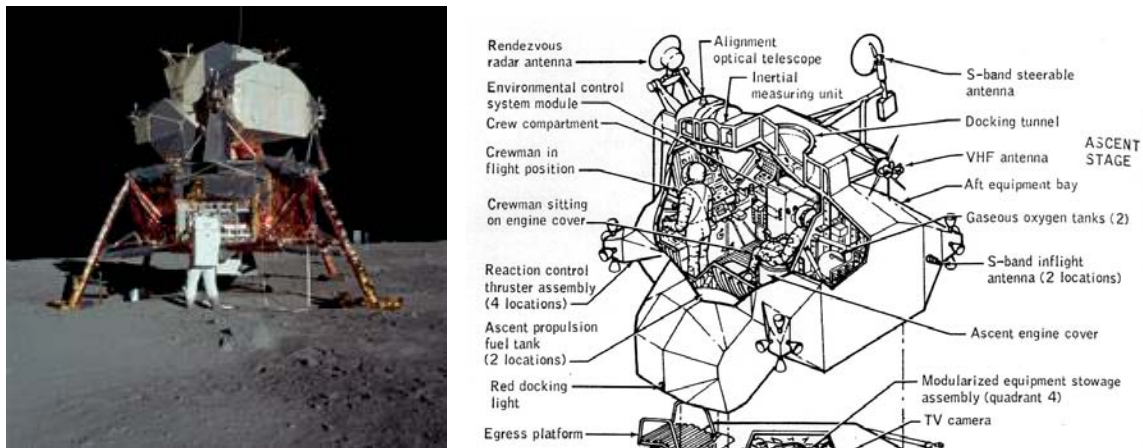

Figure 8: Apollo 11 lander and sketch of the habitable interior of the Ascent Stage.¹⁹²⁰

IV. Space Applications

Human exploration of extraterrestrial surfaces is still in its early stages. Since the NASA Apollo missions there has been no other human presence on other celestial bodies in the Solar system. Apollo missions were a breakthrough in organization of people and technology proving that human expansion to space is possible. The nine year development time frame was accomplished thanks to high motivation, efficient and lean organization and the management system of NASA. The safety needs were much lower than required nowadays. Risk-taking was part of every development stage since the Apollo program was under pressure to accomplish its goal within the given nine-year term. The speed with which the entire project was accomplished did not allow for development of the highly redundant and reusable systems that are required in current human space exploration but it did require development of high fidelity analog systems. Not only has the SHEE project developed a high fidelity lander, surface habitat and command modules but a landing site has also been developed, duplicating the Apollo lunar landing site. Reduced gravity trainers have also been developed (see Figure 1).

Future planetary human exploration calls for habitats that have an efficient and safe construction to provide a secure base for humans to venture out on EVAs and conduct scientific research on planetary surfaces and provide modular solutions for settlement clusters (Figure 9).

The SHEE project addresses the fairly unexplored area of rapidly deployable habitat structures using robotics and integrating the main subsystems within the structural components.

SHEE is being developed as a reusable, foldable and deployable analog research platform for surface planetary exploration. Broad applications for lunar or Martian environments are foreseen and are being theoretically studied in closed laboratory-like conditions or in natural environments on Earth where extremes are represented by limited infrastructure such as power, sewage, water supply and confined conditions. The partially self-sustainable, universal-mission SHEE will provide short-term autonomy for mid-fidelity simulations.

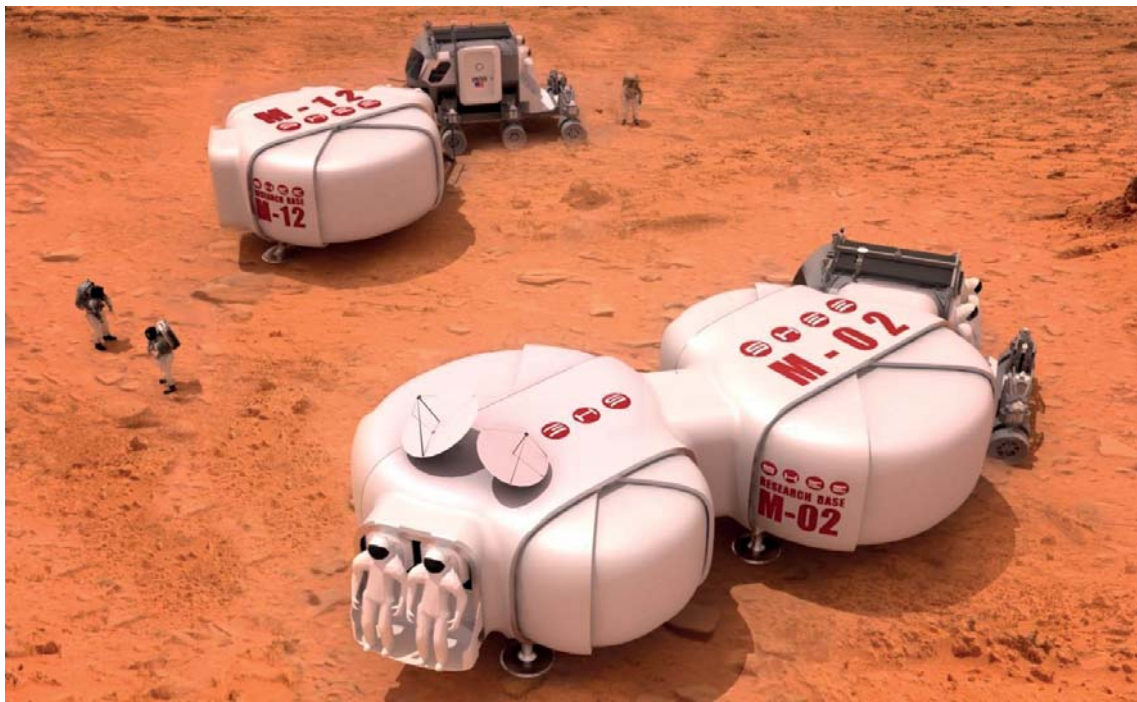

Figure 9: SHEE habitats in a cluster of three used for 6 member crew simulations in the desert as a Mars Analog base.

V. Terrestrial Applications

Terrestrial extreme environments are also within the scope of SHEE operations. With respect to applications for natural disaster prevention and post-disaster mitigation, SHEE, with a distinctive high-tech infrastructure, could play an important role in providing necessary integrated facilities to stand alone or in clusters due to its modular, compact and deployable design. Currently, there is a large market for deployable habitats for a wide range of terrestrial applications. Habitats made from deployable shipping containers are being used on construction sites, field hospitals and military bases around the world²¹. These containers are easily transported using existing infrastructure such as trailers and cargo boats. Multiple containers can be linked together into clusters to accommodate larger facilities. Possible deployable containers are also being offered for military purposes²¹, but for now their architecture lacks efficient clustering possibilities. ISO container hospital clusters were used in post disaster management in the past (e.g. container hospital in Haiti) (see Figure 10). However inexpensive and versatile deployable shipping containers still present a number of limitations.



Figure 10: ISO container clinic on the left, deployable shelter in the center²², and a container hospital cluster on the right.

Shipping container habitats provide a high volumetric packing ratio at the expense of space for internal furnishings and equipment. This equipment must be shipped and installed separately at an added expense. Most of these containers only include very basic environmental control such as heating, cooling, and ventilation. Shipping containers are therefore unsuited for operations where isolation from the operational environment is essential.

The SHEE design overcomes many of the limitations of shipping container habitats. Internal furnishings and equipment are incorporated directly into the design of the habitat while expendables such as food and water are delivered separately in modular containers. This reduces shipping expenses and the amount of labor required for deployment.

While single module units of a modified SHEE could also be useful for long term missions in isolated environments e.g., for scientific research or monitoring in natural environments where ecological sustainability is required (Figure 12), clusters would be more beneficial for rescue and high capacity emergency camps or semi-permanent settlements or bases (Figure 11).

The SHEE thus represents an original concept and the first stage of a self-sustainable and self-deployable housing test-bed for any environment.



Figure 11: Advanced SHEE for rescue and longer term emergency camps.

SHEE could effectively serve as an analog to a lunar, Martian or even terrestrial exploration laboratory (Figure 13). While on Mars the research will focus for example on finding traces of life, on the Moon one of the research goals will include geology research for studying solar system and galaxy evolution as meteoroids or asteroids have been preserved on the lunar surface for a long time. In remote areas on the Earth, SHEE extraterrestrial surface stays can be simulated and research conducted in extreme environments to look for specific geological, biological and chemical samples. Apart from fulfilling functions as a habitat, SHEE can be well outfitted as a laboratory for Mars or Moon exploration.



Figure 12: Advanced SHEE for rescue and longer term research stations in remote environments on Earth.

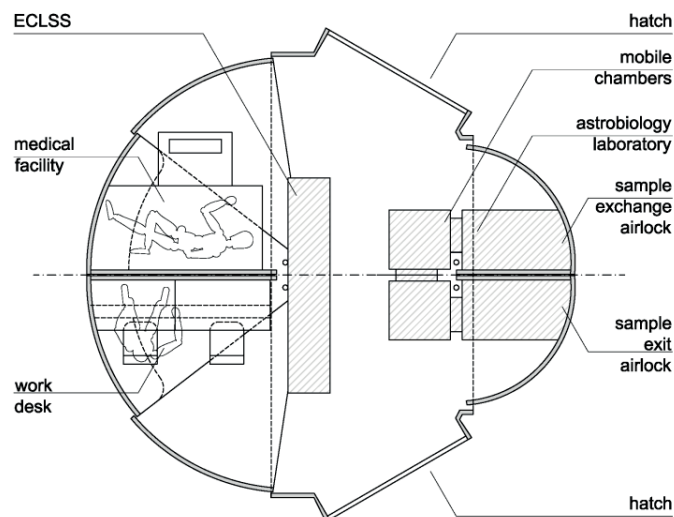

Figure 13: SHEE outfitted as a laboratory

Furthermore, SHEE can also be used as a greenhouse when outfitted accordingly (Figure 14). Apart from the shelf-type horizontal hydroponic systems, new approaches have been prototyped where plants are set vertically or in a cylindrical shape.

Due to the limited volume, plants might only be grown to complement daily meals. It is estimated that a person needs approximately between 1.8 kg and 2.5 kg of food per day (including added water in dry food). The growing area required to grow sufficient food is approximately 26 m² per person which exceeds the dimensions of SHEE.

Generally, greenhouses are quite crew time intensive if they are not fully automated. On the other hand activities in a greenhouse can contribute positively to the well-being of the crew.

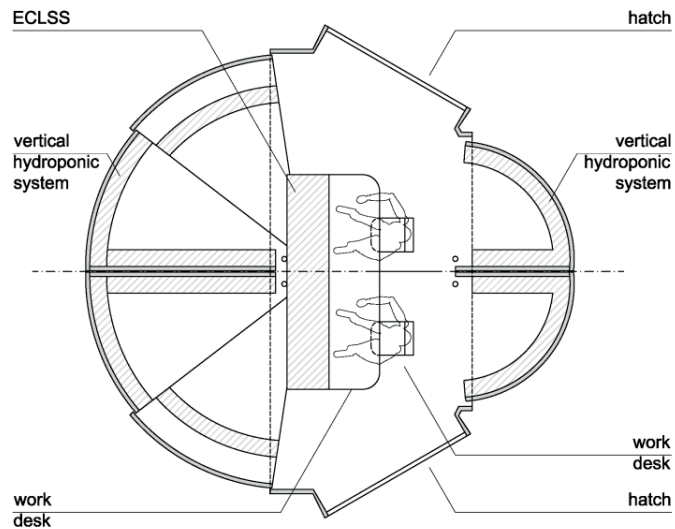

Figure 14: SHEE outfitted as a greenhouse

IV. SHEE Research capacity

SHEE is a small but flexible research platform for simulations and experiments in areas of habitat non-invasive research that can be performed in natural or laboratory conditions. The habitat supports flexible internal configurations as well as flexible external docking capacity and modular connectivity. SHEE is designed to be upgraded by research or tested to enhance its performance. It provides a large scope of opportunities for researchers worldwide in areas of technology testing, analog systems design, human-system integration, and analog operations. A non-exhaustive list is provided to point out the habitat's capacity.

A. Robotic construction / deployment and initialization

The primary goal of the extra-terrestrial architecture is to master the autonomy and automation of the construction process. The geometry of the cargo bay/payload shroud defines the packed geometry while the deployed geometry is fully unconstrained. In the case of SHEE, the deployment process has a few modes of deployment. The entire system is based on deployment of rigid components that represent an innovative and basic system in deployable structures:

- Autonomous deployment
- Remotely controlled deployment
- Subsystems risks during deployment
- Manual overrides
- Human-system interaction etc.

B. Technology test-bed

Systems and subsystems examples available for implementation and testing:

- Systems safety
- Systems affordance
- Space analog structures
- Deployment systems
- Level of autonomy and automation
- Subsystems integration and coupling
- ECLSS efficiency and operations
- Regenerative LSS subsystems test-bed

- Dust mitigation techniques
- Illumination
- Monitoring and situational awareness systems

C. Ergonomics and Human Factors studies

- Operational studies and functions analyses
- Confined environment studies
- Simulated EVA operations
- Human robotic interaction
- Human-system integration
- Confined environment psychology and performance

D. Design research

The SHEE analog platform is just a first step toward a more sophisticated analog station of higher capacity, autonomy and endurance. Numerous topics and design research elements can be explored and addressed for further SHEE development as a lunar or Martian base.

- SHEE II development – larger capacity higher performance
- Subsystems miniaturization
- Internal furnishing studies
- Function allocation
- Subsystems integrations
- Foldability / higher capacity
- Transportability / improvement of mass/volume ratio
- Energy and ECLSS self-sufficiency studies for habitat

E. Analog operations

- EVA donning doffing
- Docking an exterior research platform with exchangeable suit ports panel – customizable ports
- Supply chain and resources exchange
- Emergency and evacuation procedures
- Transport and transformation
- Sampling and in-situ post-processing in habitat laboratory

V. Conclusions

After completion, the SHEE will undergo extensive verification and testing at the International Space University during the second half of 2015. Exterior operational testing on an analog site will be conducted in 2016 at a Mars analog environment in Rio Tinto, Spain as a part of independent mission. It is anticipated that SHEE will participate in additional analog campaigns after Rio Tinto. The SHEE team therefore plans broad dissemination activities to provide information about the habitat and its progress to the respective community and, after the habitat's completion, to offer possibilities for extended simulations and outreach internationally. Currently there is no similar operational habitat in Europe capable of complex space habitation process simulation. SHEE will partially fill this gap providing complex and portable habitat hardware internationally.

Acknowledgments

The SHEE team wishes to thank the European Commission for providing the initial financial support to make the SHEE project a reality under the FP7 Space programme.

Appendix I.

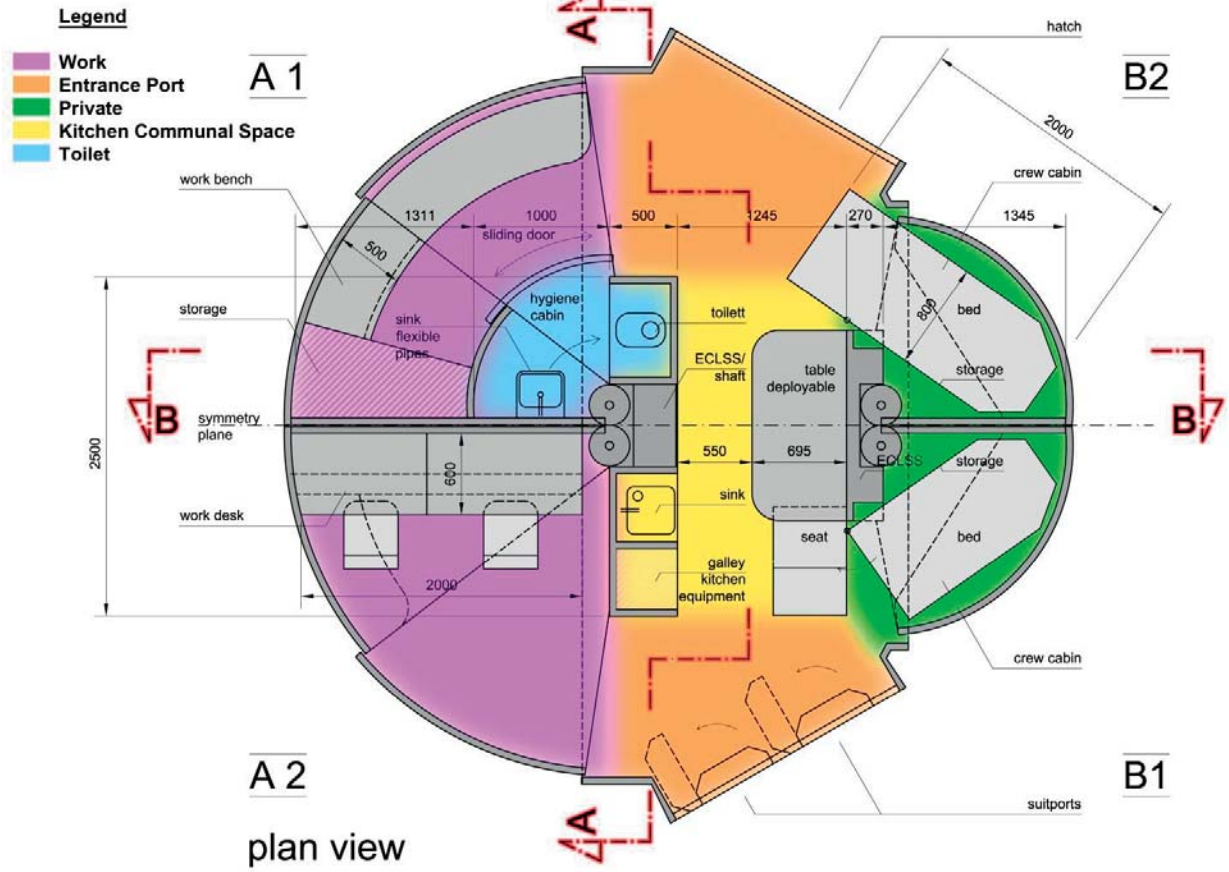

- Legend**
- Work
 - Entrance Port
 - Private
 - Kitchen Communal Space
 - Toilet

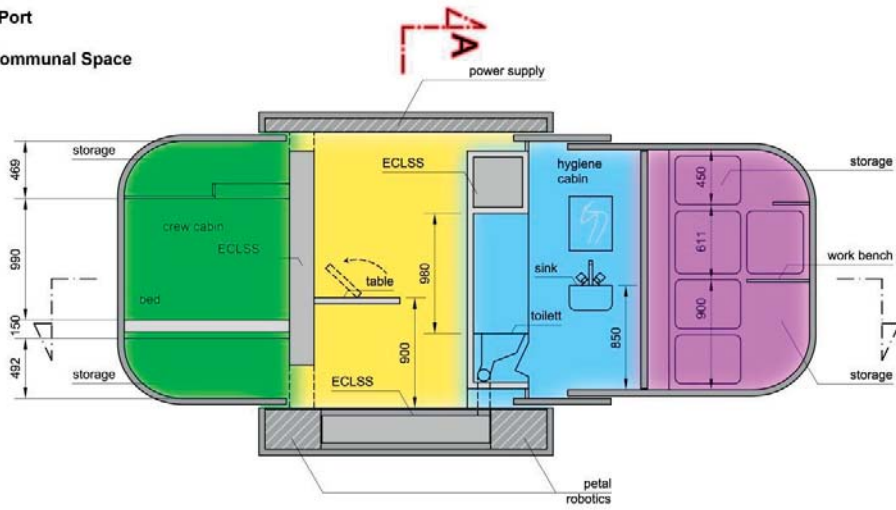

section B-B

- Legend**
- Work
 - Entrance Port
 - Private
 - Kitchen Communal Space
 - Toilet

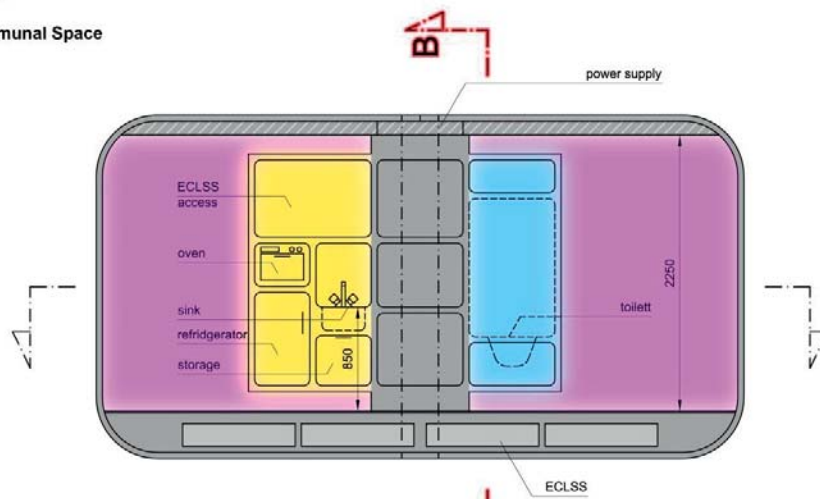

section A-A
elevation ECLSS rack A

References

-
- ¹ Doule, O., Imhof, B., Hohender, W., Aablo, A., Welch, C., Šálený, V., Ilzkovitz, M., Gancet, J. & Weiss, P., “Self-deployable Habitat for Extreme Environments - Innovative Architecture Test-bed for Terrestrial and Space Applications”, 64th International Astronautical Congress, Beijing, China, 2013
- ² Cromwell, R. L., Neigut, J. S., “Human Research Program, Huma Exploration Research Analog (HERA) Experiment Information Package”, NASA Flight Analogs Project, 2013.
- ³ Gill, T., R., Merbitz, J., C., Kennedy, K., J., Troups, L., Tri, T. O., Howe, A. S., “Habitat Demonstration Unit Pressurized Excursion Module Systems Integration Strategy”, 41st International Conference on Environmental Systems (ICES), Portland, Oregon, USA, 17-21 July 2011.
- ⁴ Farnsworth, N., David, D. A. “Mars Desert Research Station,” American Physical Society, Four Corners Meeting, 2003, October 24-25, 2003 Arizona State University, Tempe, Arizona, [online database], URL: <http://adsabs.harvard.edu/abs/2003APS.4CF.S7007F> [cited 14 July 2014].
- ⁵ Ferrone, K., Cusack, S. L., Garvin, Ch., Kramer, W. V., Palaia, J. E., Shiro, B. F., “Flashline Mars Arctic Research Station (FMARS) 2009 Crew Perspectives,” American Institute of Aeronautics and Astronautics, 2010-2258, SpaceOps Conference, Huntsville, AL, USA, 25–30 April, 2010.
- ⁶ Lee, P., “Mars on Earth: The NASA Haughton-mars Project,” *Ad Astra*, pp. 12-15, 51-53, URL: <http://nss.cyberteam.com/adastra/volume14/v14n3/contents/v14n3F1.pdf> [cited 14 July 2014].
- ⁷ Binsted, K. A., Hunter, J. B., “Analog Sites for Mars Missions II, HI-SEAS (Hawaii Space Analog and Simulation, hi-ses.org) as an opportunity for long-duration instrument/protocol testing and verification,” University of Hawaii at Manoa, 2013, URL: <http://www.hou.usra.edu/meetings/analogs2013/pdf/4044.pdf> [cited 14 July, 2014].
- ⁸ Todd, B., Reaga, M., “The NEEMO Undersea Analog: Another Type of Deep Space Exploration,” *AIAA Space 2005-6754*, 30 August – 1 September, Long Beach, California, 2005.
- ⁹ Gibbs, Y., “NASA Armstrong Fact Sheet: Lunar Landing Research Vehicle,” Armstrong Flight Research Center, 2014, URL: <http://www.nasa.gov/centers/armstrong/news/FactSheets/FS-026-DFRC.html#.U5hB5UaaqPM> [cited 14 July 2014].
- ¹⁰ Kring, A. D., “Cinder Lake Crater Field, Arizona Lunar Analogue Test Site,” *Kring/Space Sciences, Lunar Exploration Initiative*, July 2008, URL: http://www.lpi.usra.edu/science/kring/lunar_exploration/CinderLakesCraterField.pdf [cited 14 July 2014].
- ¹¹ Griffin, T. M., Tolani, N. A., Kram, R., “Walking in simulated reduced gravity: mechanical energy fluctuations and exchange,” *Journal of Applied Physiology*, Published 1 January 1999, Vol. 86, pp. 383-390, [online database] URL: <http://jap.physiology.org/content/86/1/383> [cited 14 July 2014].
- ¹² Tri, T. O., Kennedy, K., J., Troups, L., “Planning and Logistics for the In-Field Demonstration of NASA’s Habitat Demonstration Unit (HDU) Pressurized Excursion Module (PEM) at Desert RATS 2010”, *41st International Conference on Environmental Systems*, 17-21 July, Portland, Oregon, 2011.
- ¹³ Paige, D., “DIVINER Lunar Radiometer Experiment,” Diviner Commissioning Observations, URL: <http://www.diviner.ucla.edu/blog/?p=123> [cited 14 July 2014].
- ¹⁴ Williams, D.R., “Moon Fact Sheet,” NASA Goddard Space Flight Center, URL: <http://nssdc.gsfc.nasa.gov/planetary/factsheet/moonfact.html> [cited 14 July 2014].
- ¹⁵ Hargitai, H., Brczi, Sz., Nagy, Sz., Gucsik, A., “Mars Climate Diagram Database,” *Lunar and Planetary Science Volume 39*, 2008.
- ¹⁶ Flinn, E.A., “Scientific results of the Viking Project,” *Journal of Geophysical Research*, volume 82, September 30, Washington, D.C., pp. 735, 1977.
- ¹⁷ Lyons, W.A, ‘The Handy Weather Answer Book,’ (2nd ed.), Detroit, Michigan: Visible Ink press, ISBN 0-7876-1034-8, 1997.
- ¹⁸ NASA, “Constellation Program: America’s Spacecraft for a New Generation of Explorers, The Altair Lunar Lander,” NASA Facts, Lyndon B. Johnson Space Center, Houston, Texas, FS-2008-09-007-JSC, 2008, [online database], URL: http://www.nasa.gov/pdf/289914main_fs_altair_lunar_lander.pdf [cited 14 July 2013].
- ¹⁹ Teague, K., Garber, S., “Project Apollo Drawings and Technical Diagrams,” NASA History Program Office, [online database], URL: <http://history.nasa.gov/diagrams/apollo.html> [cited 14 July 2014].

²⁰ Teague, K., Garber, S., “Project Apollo Drawings and Technical Diagrams,” NASA History Program Office, [online database], URL: <http://history.nasa.gov/diagrams/ad002.gif> [cited 14 July 2014].

²¹ Military Technology, “Marshall Land Systems Role 2 Field Hospitals for Norway,” Military Technology, Vol. 33 Issue 2, p61-62. 2p., 2009, [online database], URL: <http://www.militarysystems-tech.com/suppliers/deployable-and-expandable-integrated-shelter-solutions/marshall-land-systems> [cited 14 July 2014].

²² Business Wire, “Containers to Clinics Opens Doors of Pilot Facility, Begins Treating Patients in Haiti,” Business Wire, New York, 2010, [online database], URL: <http://search.proquest.com.portal.lib.fit.edu/docview/805053857/abstract?accountid=27313> [cited 14 July].